



**INTERCONNECTION  
FACILITIES STUDY  
REPORT**

GEN-2017-171

Published April 2023

By SPP Generator Interconnections Dept.

## REVISION HISTORY

DATE OR VERSION NUMBER	AUTHOR	CHANGE DESCRIPTION
04/12/2023	SPP	Initial draft report issued.
05/02/2023	SPP	Updated upgrade information and cost for UIDs 156445 & 156471 in Table 3.
06/08/2023	SPP	Updated upgrade information and cost for UID 143435 in Table 1.
06/21/2023	SPP	Final report issued.
06/28/2023	SPP	Cost revisions made to UIDs 143434 and 156858 in Table 3.

# CONTENTS

---

Revision History .....	i
Summary .....	1
Introduction .....	1
Phase(s) of Interconnection Service .....	1
Compensation for Amounts Advanced for Network Upgrade(s).....	1
Interconnection Customer Interconnection Facilities .....	2
Transmission Owner Interconnection Facilities and Non-Shared Network Upgrade(s).....	3
Shared Network Upgrade(s) .....	4
Contingent Network Upgrade(s).....	7
Affected System Upgrade(s) .....	8
Conclusion.....	9
Appendices .....	10
A: Transmission Owner’s Interconnection Facilities Study Report and Network Upgrades Report(s).....	1

## SUMMARY

---

### INTRODUCTION

This Interconnection Facilities Study (IFS) for Interconnection Request is for a 150 MW generating facility located in Stephen County, OK. The Interconnection Request was studied in the DISIS-2017-002 Impact Study for ERIS. The Interconnection Customer's requested in-service date is December 01, 2025.

The interconnecting Transmission Owner, American Electric Power Company (AEP), performed a detailed IFS at the request of SPP. The full report is included in Appendix A. SPP has determined that full Interconnection Service will be available after the assigned Transmission Owner Interconnection Facilities (TOIF), Non-Shared Network Upgrades, Shared Network Upgrades, Contingent Network Upgrades, and Affected System Upgrades that are required for full interconnection service are completed.

The primary objective of the IFS is to identify necessary Transmission Owner Interconnection Facilities, Network Upgrades, other direct assigned upgrades, cost estimates, and associated upgrade lead times needed to grant the requested Interconnection Service.

### PHASE(S) OF INTERCONNECTION SERVICE

It is not expected that Interconnection Service will occur in phases. However, full Interconnection Service will not be available until all Interconnection Facilities and Network Upgrade(s) can be placed in service.

### COMPENSATION FOR AMOUNTS ADVANCED FOR NETWORK UPGRADE(S)

FERC Order ER20-1687-000 eliminated the use of Attachment Z2 revenue crediting as an option for compensation. The Incremental Long Term Congestion Right (ILTCR) process will be the sole process to compensate upgrade sponsors as of July 1st, 2020.

## **INTERCONNECTION CUSTOMER INTERCONNECTION FACILITIES**

The Generating Facility is proposed to consist of (41) 4.05 MVA Inverters for a total generating nameplate capacity of 150 MW.

The Interconnection Customer's Interconnection Facilities to be designed, procured, constructed, installed, maintained, and owned by the Interconnection Customer at its sole expense include:

34.5 kV underground cable collection circuits;

34.5 kV to 345 kV transformation substation with associated 34.5 kV and 345 kV switchgear;

One 345/34.5 kV 102/136/170 MVA (ONAN/ONAF/ONAF) step-up transformer to be owned and maintained by the Interconnection Customer at the Interconnection Customer's substation;

Approx. 0.18 mile 345 kV line to connect the Interconnection Customer's substation to the Point of Interconnection ("POI") at the 345 kV bus at existing Transmission Owner substation ("Lawton Eastside - Terry Road 345kV") that is owned and maintained by Transmission Owner;

All transmission facilities required to connect the Interconnection Customer's substation to the POI;

Equipment at the Interconnection Customer's substation necessary to maintain a composite power delivery at continuous rated power output at the high-side of the generator substation at a power factor within the range of 95% lagging and 95% leading in accordance with Federal Energy Regulatory Commission (FERC) Order 827. The Interconnection Customer may use inverter manufacturing options for providing reactive power under no/reduced generation conditions. The Interconnection Customer will be required to provide documentation and design specifications demonstrating how the requirements are met; and,

All necessary relay, protection, control and communication systems required to protect Interconnection Customer's Interconnection Facilities and Generating Facilities and coordinate with Transmission Owner's relay, protection, control and communication systems.

**TRANSMISSION OWNER INTERCONNECTION FACILITIES AND NON-SHARED NETWORK UPGRADE(S)**

To facilitate interconnection, the interconnecting Transmission Owner will perform work as shown below necessary for the acceptance of the Interconnection Customer’s Interconnection Facilities.

**Table 1** and **Table 2** lists the Interconnection Customer’s estimated cost responsibility for Transmission Owner Interconnection Facilities (TOIF) and Non-Shared Network Upgrade(s) and provides an estimated lead time for completion of construction. The estimated lead time begins when the Generator Interconnection Agreement has been fully executed.

*Table 1: Transmission Owner Interconnection Facilities (TOIF)*

<b>Transmission Owner Interconnection Facilities (TOIF)</b>	<b>Total Cost Estimate (\$)</b>	<b>Allocated Percent (%)</b>	<b>Allocated Cost Estimate (\$)</b>	<b>Estimated Lead Time</b>
<b><u>Lawton Eastside - Terry Road 345kV GEN-2017-171 Interconnection (TOIF) (AEP) (143435):</u></b> Interconnection upgrades and cost estimates needed to interconnect the following Interconnection Customer facility, GEN-2017-171 (150 MW/Solar), into the Point of Interconnection (POI) at Lawton Eastside - Terry Road 345kV	\$3,876,319	60%	\$2,325,791.40	36 Months
<b>Total</b>	<b>\$3,876,319</b>		<b>\$2,325,791.40</b>	

*Table 2: Non-Shared Network Upgrade(s)*

<b>Non-Shared Network Upgrades Description</b>	<b>ILTCR</b>	<b>Total Cost Estimate (\$)</b>	<b>Allocated Percent (%)</b>	<b>Allocated Cost Estimate (\$)</b>	<b>Estimated Lead Time</b>
<b><u>NA</u></b>	<b>NA</b>	<b>NA</b>	<b>NA</b>	<b>NA</b>	<b>NA</b>
<b>Total</b>		NA		NA	

**SHARED NETWORK UPGRADE(S)**

The Interconnection Customer’s share of costs for Shared Network Upgrades is estimated in **Table 3** below.

*Table 3: Interconnection Customer Shared Network Upgrade(s)*

Shared Network Upgrades Description	ILTCR	Total Cost Estimate (\$)	Allocated Percent (%)	Allocated Cost Estimate (\$)	Estimated Lead Time
<b><u>Lawton Eastside - Terry Road 345kV New Interconnection Substation (DISIS-2017-002)(143434):</u></b> <u>Construct a new Lawton Eastside - Terry Road 345kV substation to accommodate the interconnection of GEN-2017-171, GEN-2017-172, and GEN-2017-173</u>	Ineligible	\$18,137,968	60%	\$10,882,780.80	36 Months
<b><u>Reactive Support at Randall 230kV(156857):</u></b> <u>Install three (3) 28.8 MVAR capacitor banks, one (1) 14.4 MVAR capacitor bank, and a 100 MVar STATCOM at Randall 230 kV</u>	Eligible	\$66,361,449	16.61%	\$11,022,262.86	36 Months
<b><u>Reactive Support at Sweetwater 230kV(156858):</u></b> <u>Install a total of 64 MVAR of capacitor banks and a 106 MVar STATCOM at Sweetwater 230 kV</u>	Eligible	\$58,762,790	16.61%	\$9,760,168.40	36 Months
<b><u>Renfrow 345 kV Terminal Equipment Upgrade (DISIS-2017-002) (OGE)(156445):</u></b> <u>Upgrade terminal equipment at point of change (OK/KS State Line) to accept Viola 345 kV line rebuild to achieve minimum summer/emergency rating of 1195 MVA.</u>	Eligible	\$250,000	2.33%	\$5,817.06	36 Months
<b><u>Rocky Point Terminal Equipment Upgrade (DISIS-2017-002)(156487):</u></b> <u>Upgrade terminal equipment</u>	Eligible	\$634,858	15.28%	\$96,998.00	18 Months

<u>at Rocky Point 138 kV for the Rocky Point to Sunnyside 138 kV line to achieve minimum summer/emergency rating of 205 MVA</u>					
<b><u>Switch Out Border Line Reactor (DISIS-2017-002)(156496):</u></b> <u>Switch out the Border 345 kV (50 MVAR) - Tuco line reactors to be switchable</u>	Eligible	\$1,790,448	16.61%	\$297,383.33	20 Months
<b><u>Switch Out Carpenter Line Reactor (DISIS-2017-002)(156493):</u></b> <u>Switch out the Carpenter 25 MVAR line reactor on the Carpenter to Hitchland 345 kV line to be remote switchable.</u>	Eligible	\$836,245	16.61%	\$138,895.58	36 Months
<b><u>Switch Out Finney and Carpenter Line Reactors (DISIS-2017-002)(156495):</u></b> <u>Switch out the Finney 345 kV (50 MVAR) - Carpenter 345 kV (25 MVAR) 345kV line reactors to be switchable</u>	Eligible	\$1,884,762	16.61%	\$313,048.35	1 Month
<b><u>Switch Out Potter County Line Reactor (DISIS-2017-002)(156494):</u></b> <u>Switch out the Potter County 345 kV 75 MVAR line reactor on the Potter County to Hitchland 345 kV line to be remote switchable</u>	Eligible	\$1,228,089	16.61%	\$203,978.67	36 Months
<b><u>Switch Out Tuco Line Reactor (DISIS-2017-002)(156497):</u></b> <u>Switch out the Border 345 kV (50 MVAR) - Tuco 345 kV (100 MVAR) 345kV line reactors to be switchable</u>	Eligible	\$2,316,446	16.61%	\$384,748.63	36 Months
<b><u>Viola to Renfrow 345 kV Rebuild (WERE) (DISIS-2017-002) (156471):</u></b> <u>Rebuild the existing Viola to Renfrow 345 kV line from Viola to the OK/KS State Line</u>	Eligible	\$47,418,633	2.33%	\$1,103,347.61	36 Months



<u>(23 miles) to achieve a minimum summer/emergency rating of 1195 MVA</u>					
<b>Total</b>		<b>\$199,621,688.00</b>		<b>\$34,209,429.29</b>	

All studies have been conducted assuming that higher-queued Interconnection Request(s) and the associated Network Upgrade(s) will be placed into service. If higher-queued Interconnection Request(s) withdraw from the queue, suspend or terminate service, the Interconnection Customer's share of costs may be revised. Restudies, conducted at the customer's expense, will determine the Interconnection Customer's revised allocation of Shared Network Upgrades.

### CONTINGENT NETWORK UPGRADE(S)

Certain Contingent Network Upgrades are **currently not the cost responsibility** of the Interconnection Customer but will be required for full Interconnection Service.

*Table 4: Interconnection Customer Contingent Network Upgrade(s)*

<b>Contingent Network Upgrade(s) Description</b>	<b>Current Cost Assignment</b>	<b>Estimated In-Service Date</b>
<u>NA</u>	<u>NA</u>	<u>NA</u>

Depending upon the status of higher- or equally-queued customers, the Interconnection Request’s in-service date is at risk of being delayed or Interconnection Service is at risk of being reduced until the in-service date of these Contingent Network Upgrades.

**AFFECTED SYSTEM UPGRADE(S)**

To facilitate interconnection, the Affected System Transmission Owner will be required to perform the facilities study work as shown below necessary for the acceptance of the Interconnection Customer’s Interconnection Facilities. **Table 5** displays the current impact study costs provided by either MISO or AEI as part of the Affected System Impact review. The Affected System facilities study could provide revised costs and will provide each Interconnection Customer’s allocation responsibilities for the upgrades.

*Table 5: Interconnection Customer Affected System Upgrade(s)*

<b>Affected System Upgrades Description</b>	<b>Total Cost Estimate (\$)</b>	<b>Allocated Percent (%)</b>	<b>Allocated Cost Estimate (\$)</b>
<b>Upgrade Name from AFS:</b> Upgrade Description from AFS	\$	%	\$
<b>Total</b>	\$		\$

## CONCLUSION

After all Interconnection Facilities and Network Upgrades have been placed into service, Interconnection Service for MW can be granted. Full Interconnection Service will be delayed until the TOIF, Non-Shared NU, Shared NU, Contingent NU, Affected System Upgrades that are required for full interconnection service are completed. The Interconnection Customer’s estimated cost responsibility for full interconnection service is summarized in the table below.

*Table 6: Cost Summary*

Description	Allocated Cost Estimate
Transmission Owner Interconnection Facilities Upgrade(s)	\$2,325,791.40
Non-Shared Network Upgrade(s)	\$0
Shared Network Upgrade(s)	\$34,209,429.29
Affected System Upgrade(s)	\$0
<b>Total</b>	<b>\$36,535,220.69</b>

Use the following link for Quarterly Updates on upgrades from this report: <https://spp.org/spp-documents-filings/?id=18641>

A draft Generator Interconnection Agreement will be provided to the Interconnection Customer consistent with the final results of this IFS report. The Transmission Owner and Interconnection Customer will have 60 days to negotiate the terms of the GIA consistent with the SPP Open Access Transmission Tariff (OATT).

# APPENDICES

---

**A: TRANSMISSION OWNER'S INTERCONNECTION FACILITIES STUDY REPORT  
AND NETWORK UPGRADES REPORT(S)**

See next page for the Transmission Owner's Interconnection Facilities Study Report and Network Upgrades Report(s).



# **AEP Generation Interconnection**

## **Facilities Study Report**

**for**

**DISIS 2017-002**

**Reactive support at Sweetwater 230 kV station**

**Beckham County, Texas**

**March 2023**

## FACILITIES STUDY SUMMARY

American Electric Power (AEP) Southwest Transmission Planning performed the following study at the request of the Southwest Power Pool (SPP) for SPP Generation Interconnection request DISIS-2017-002. Per the SPP Generator Interconnection Procedures (GIP), SPP requested that AEP perform an Interconnection Facilities Study (IFS) for Network Upgrade(s) in accordance with Attachment V, Section 8.11 of the Generator Interconnection Procedures (GIP).

Sweetwater 230kV

Install 170 MVAR of reactive support that will include an approximately 106 MVAR Statcom and a 64 MVAR capacitor bank and associated equipment

## PROJECT DESCRIPTION

Per the DISIS-2017-002 study request, AEP proposes to Install 170 MVAR of reactive support that will include an approximately 106 MVAR Statcom and a 64 MVAR capacitor bank and associated bus work and equipment at the AEP Sweetwater station(Figure 1) in Beckham County, Oklahoma (Figure 2).

## AEP'S SCOPE OF WORK TO FACILITATE INTERCONNECTION

To accommodate the reactive support request at the Sweetwater 230 kV station, The existing configuration and footprint will need to be expanded. The design and construction of the new bus work will meet all AEP specifications. Bus work and disconnect switches will be designed to accommodate the loading requirements, and circuit breakers will be rated to ensure adequate load and fault interrupting capability. AEP will own, operate and maintain the 230 kV Sweetwater station.

Installation of associated protection and control equipment, and SCADA required at the Sweetwater 230 kV station. AEP reserves the right to specify the final acceptable configuration considering design practices, future expansion, and compliance requirements.

It is understood that the Interconnection Customers are responsible for the cost of all of this work.



## SHORT CIRCUIT EVALUATION

It is standard practice for AEP to recommend replacing a circuit breaker when the current through the breaker for a fault exceeds 100% of its interrupting rating with recloser de-rating applied, as determined by the ANSI/IEEE C37.5-1979, C37.010-1979 & C37.04-1979 breaker rating methods. In the AEP system, no breakers were found to exceed their interrupting capability after the addition of this equipment. Therefore, there are no additional short circuit upgrade costs associated with the DISIS-2017-002, UID 156858 interconnection.

## INTERCONNECTION COST OF FACILITIES INCLUDED IN THE FACILITIES STUDY:

Install 106 MVAR Statcom and 64 MVAR capacitor bank at 230 kV Sweetwater station	\$58,762,790
<b>Total Cost</b>	<b>\$58,762,790</b>

*The estimates do not include the impact that delays in obtaining ROW, permits, or other approvals may have.*

## PROJECT LEAD TIME

Project in-service date is projected to be 36-42 months after the issuance of Authorization to Proceed from the Interconnection Customer. This is primarily due to the current timeline for scoping, bidding, and acquiring the STATCOM unit.

Figure 1: Point of Interconnection (POI INFORMATION) One-Line Diagram

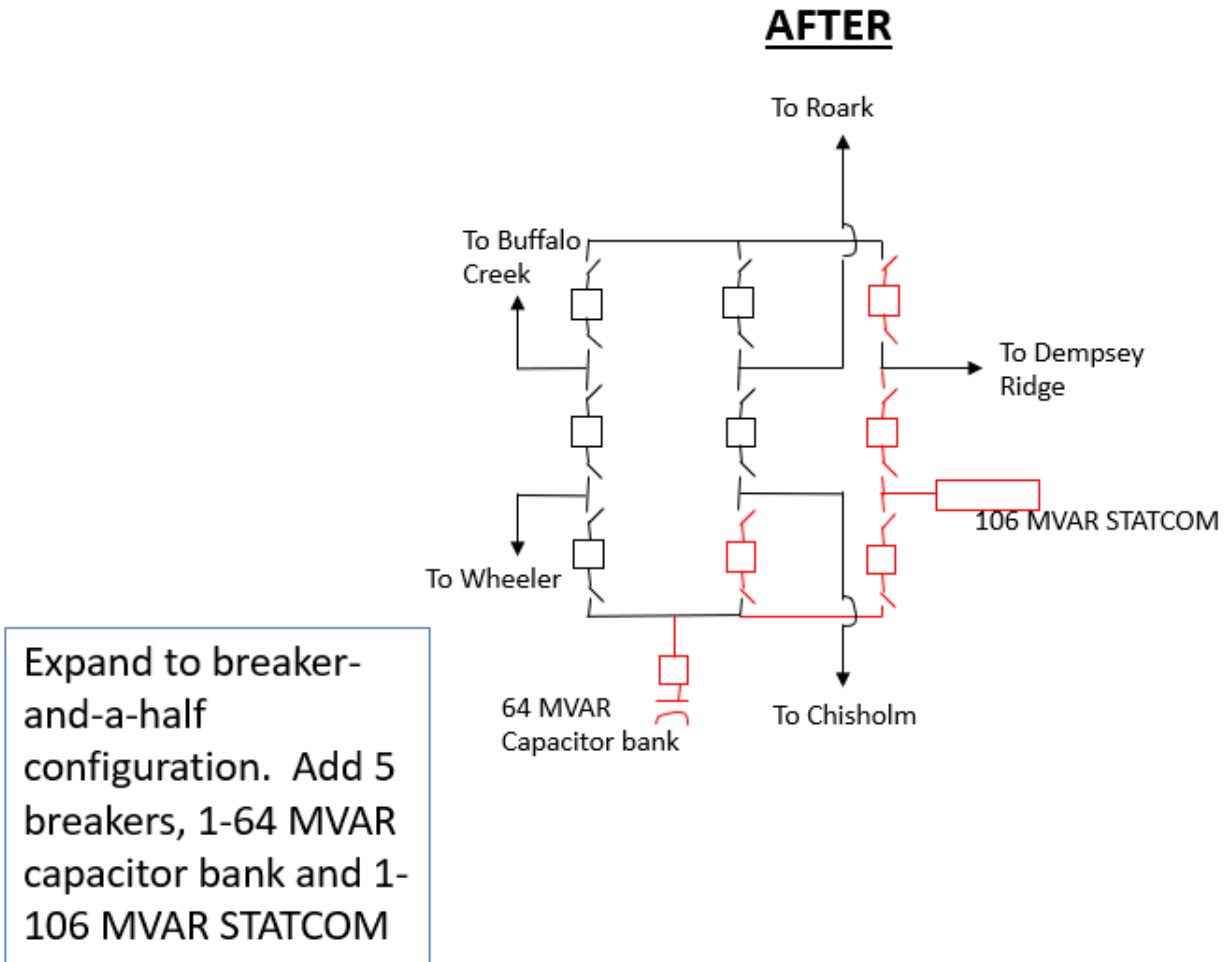
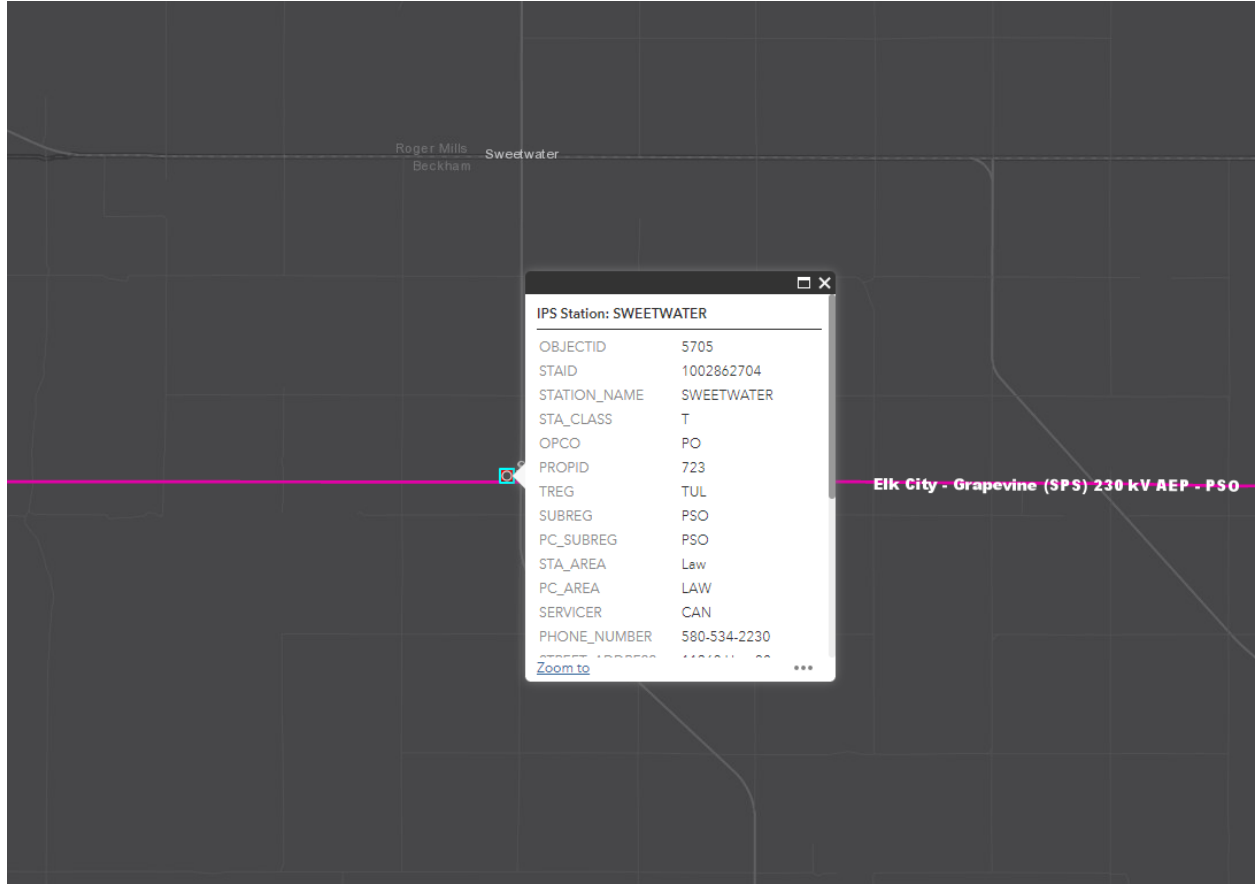

Figure 2: Point of Interconnection Map







## **Interconnection Facilities Study**

# **Network Upgrades associated with DISIS-2017-002**

**March 2023**

## **Introduction**

This report summarizes the scope of the Interconnection Facilities Analysis for Network Upgrade(s) to determine costs related to the addition of the SPP-GI DISIS-2017-002 Interconnection Request(s).

## **Southwest Power Pool Generation Interconnection Request:**

Per the SPP Generator Interconnection Procedures (GIP), SPP has requested that Evergy perform an Interconnection Facilities Study (IFS) for Network Upgrade(s) in accordance with the Scope of Interconnection Facilities Study GIP Section 8.10 and the Interconnection Facilities Study Procedures in accordance with GIP Section 8.11 for the following Interconnection Request(s):

<b>Upgrade Type</b>	<b>UID</b>	<b>Upgrade Name</b>	<b>DISIS Cost</b>	<b>DISIS Lead Time</b>
Network Upgrade	156516	Archie 161 kV Terminal Upgrades (DISIS-2017-002) (EMW)	\$1,455,934	36 Months
Network Upgrade	156851	Archie – G17-108 Tap 161 kV Rebuild (DISIS-2017-002) (EMW)	\$41,157,960	36 Months
Network Upgrade	156461	Craig to Lenexa 161 kV Double Circuit Rebuild (DISIS-2017-002) (EM)	\$8,294,859	36 Months
Network Upgrade	156457	Post Oak 69-35 kV Transformer Replacement (DISIS-2017-002) (EKC)	\$2,470,058	36 Months
Network Upgrade	156471	Viola to G17-185 Tap 345 kV Line Rebuild (DISIS-2017-002) (EKC)	\$47,418,635	36 Months

## **Archie 161 kV Terminal Upgrades 161**

### **kV Substation**

All terminal equipment to be replaced to meet a 2000 Amp rating. This will require a main bus rebuild to 4" aluminum pipe bus and includes bus side disconnects for the other three line terminals.

### **Total Cost**

The total cost estimate for this Network Upgrade is:

\$	0	161kV Transmission Line
\$	1,451,579	161kV Substation
\$	4,354	AFUDC
\$	0	Contingency
\$	1,455,934	Total

This estimate is accurate to +/- twenty (20) percent, based on current prices, in accordance with Attachment A of Appendix 4 of the Interconnection Facilities Study Agreement.

However, recent cost fluctuations in materials are very significant and the accuracy of this estimate at the time of actual settings cannot be assured.

### Time Estimate

Time estimates are based on current version of the project schedule and some processes of each category run concurrently.

Engineering Time	12-18	Months
Procurement Time	12-18	Months
Construction Time	12	Months
<b>Total Project Length</b>	<b>36-48</b>	<b>Months</b>

**Figure 1 – Archie 161 kV Sub**

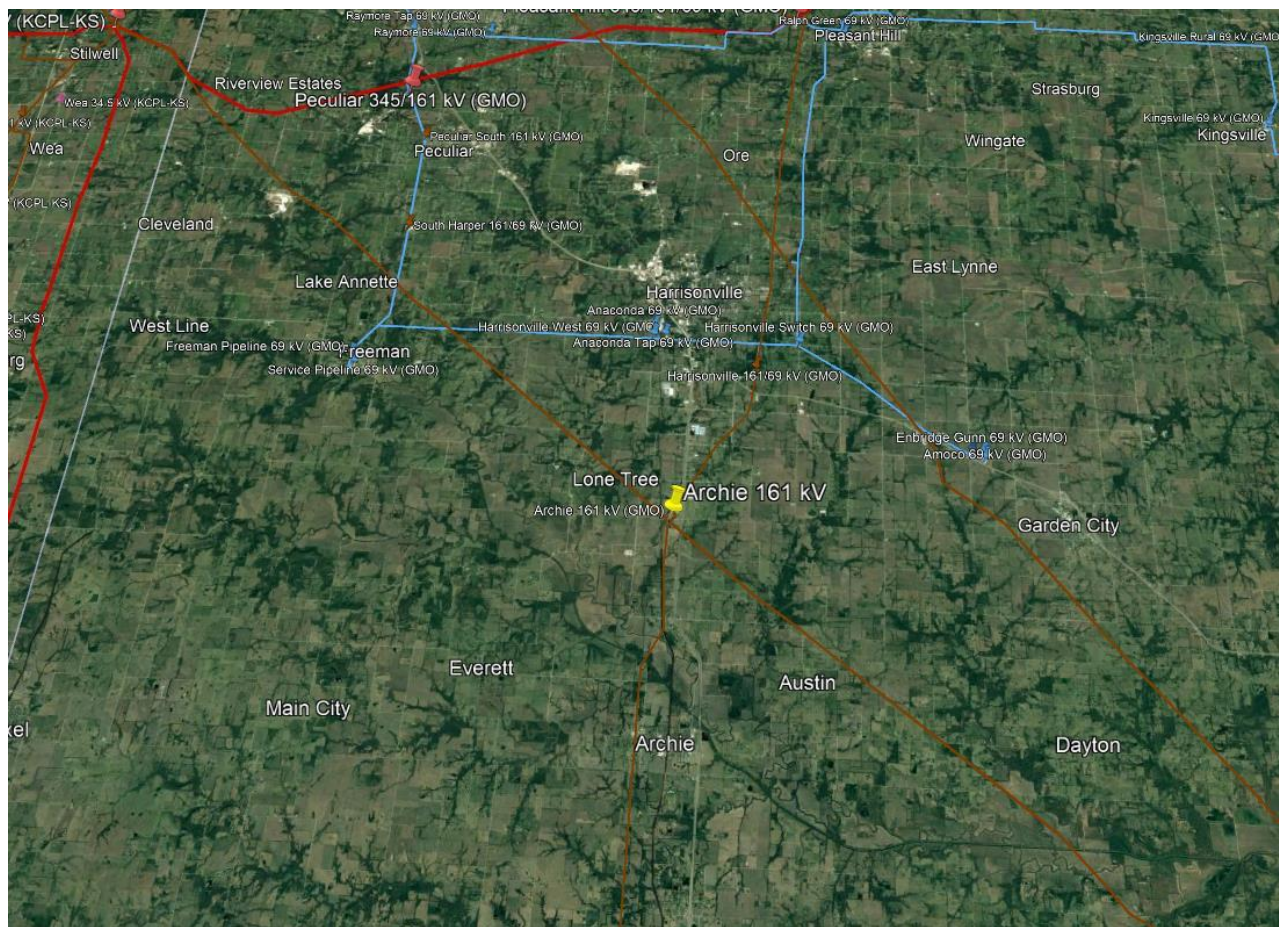

**Archie – G17-108 Tap 161 kV Rebuild 161**

**kV Transmission Line**

The estimated cost is for 28.73 miles of 161kV circuit. Line will be rebuilt using steel structures, with angles and dead-ends on drilled piers. Estimate assumes the conductor will be 1192 ACSS/TW and OPGW will be installed.

**Total Cost**

The total cost estimate for this Network Upgrade is:

\$	39,783,750	161 kV Transmission Line
\$	0	161 kV Substation
\$	1,374,210	AFUDC
\$	0	Contingency
<hr/>		
\$	41,157,960	Total

This estimate is accurate to +/- twenty (20) percent, based on current prices, in accordance with Attachment A of Appendix 4 of the Interconnection Facilities Study Agreement.

However, recent cost fluctuations in materials are very significant and the accuracy of this estimate at the time of actual settings cannot be assured.

**Time Estimate**

Time estimates are based on current version of the project schedule and some processes of each category run concurrently.

Engineering Time	12-18	Months
Procurement Time	12-18	Months
Construction Time	12	Months
<hr/>		
Total Project Length	36-48	Months



**Figure 2 – Archie – G17-108 Tap**

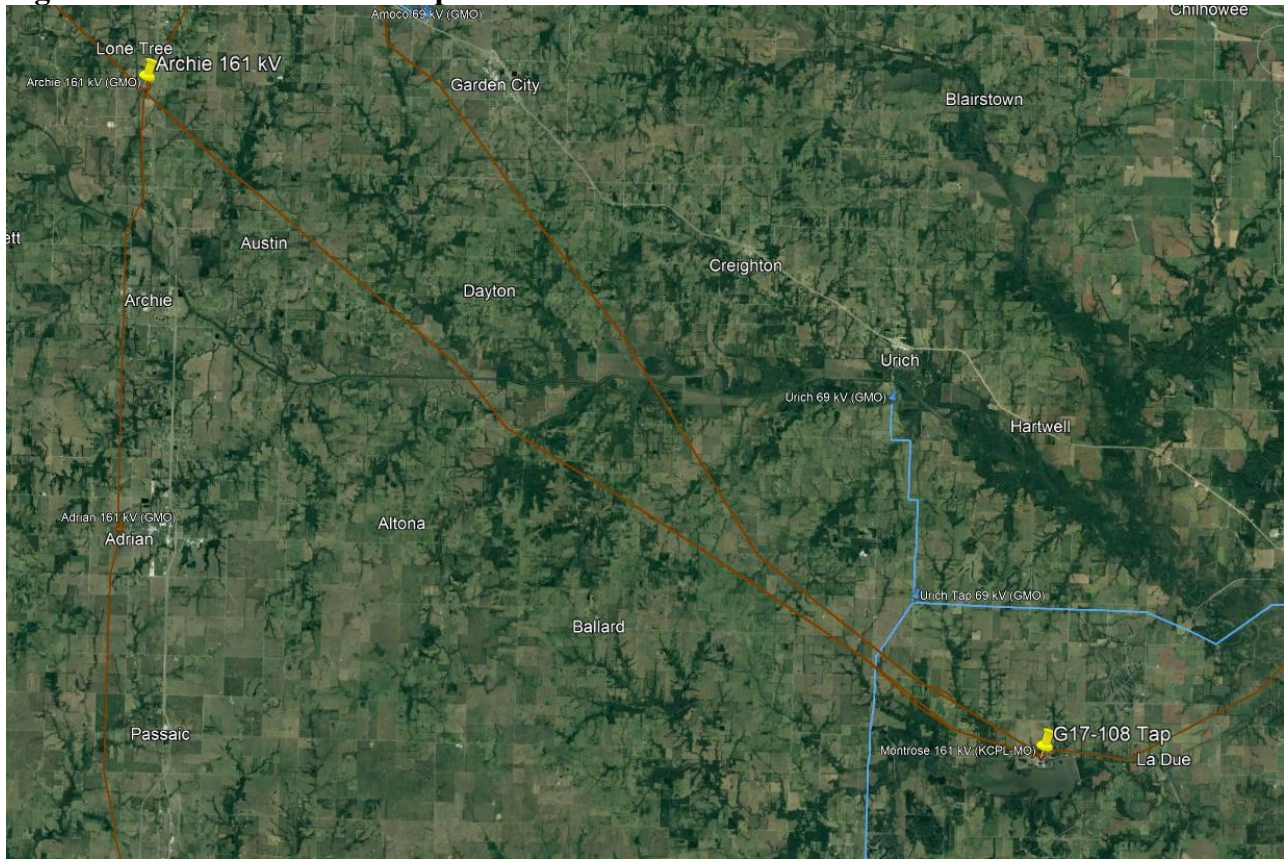

**Craig to Lenexa 161 kV Double Circuit Rebuild 161 kV**

**Transmission Line**

The estimated cost is for 2.95 miles of 161kV double circuit. The lines will be rebuilt with steel structures, 1192 ACSS/TW conductor and two OPGW's designed to Evergy standards.

**Total Cost**

The total cost estimate for this Network Upgrade is:

\$	7,763,088	161 kV Transmission Line
\$	0	161 kV Substation
\$	531,771	AFUDC
\$	0	Contingency
<hr/>		
\$	8,294,859	Total

This estimate is accurate to +/- twenty (20) percent, based on current prices, in accordance with Attachment A of Appendix 4 of the Interconnection Facilities Study Agreement. However, recent cost fluctuations in materials are very significant and the accuracy of this estimate at the time of actual settings cannot be assured.

**Time Estimate**

Time estimates are based on current version of the project schedule and some processes of each category run concurrently.

Engineering Time	12-18	Months
Procurement Time	12-18	Months
Construction Time	12	Months
<hr/> Total Project Length	<hr/> 36-48	<hr/> Months

**Figure 3 – Craig – Lenexa 161kV Line**

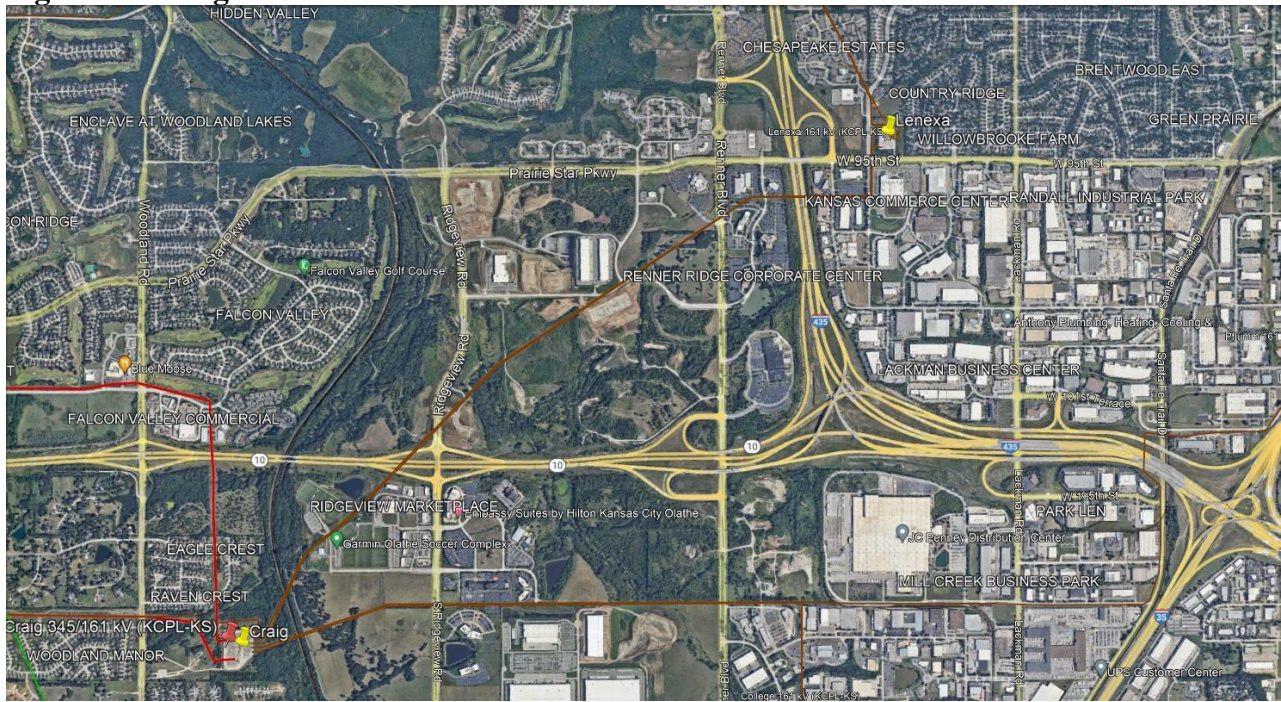

## **Post Oak 69-35 kV Transformer Replacement**

### **69 kV Transformer**

Replace Post Oak 69/35 kV Transformer with a 50MVA 69/34kV Transformer. This will also require a 34kV bank breaker, 34kV feeder breaker, box bay, RTU, control house and metering equipment.

### **Total Cost**

The total cost estimate for this Network Upgrade is:

\$	2,462,670	69 kV Substation Transformer
\$	7,388	AFUDC
\$	0	Contingency
\$	2,470,058	Total

This estimate is accurate to +/- twenty (20) percent, based on current prices, in accordance with Attachment A of Appendix 4 of the Interconnection Facilities Study Agreement. However, recent cost fluctuations in materials are very significant and the accuracy of this estimate at the time of actual settings cannot be assured.

### **Time Estimate**

Time estimates are based on current version of the project schedule and some processes of each category run concurrently.

Engineering Time	12-18	Months
Procurement Time	12-18	Months
Construction Time	12	Months
Total Project Length	36-48	Months

**Figure 4 – Post Oak – 69kV Transformer**



**Viola – Renfrow 345 kV Rebuild (Everygy Portion)**

**345 kV Transmission Line**

The estimated cost is for the rebuild of the 23-mile Everygy portion of the Viola – Renfrow 345kV line to meet a 3000 Amp line rating. Line will be rebuilt using steel structures, with angles and dead-ends on drilled piers. Estimate assumes the conductor will be 1590 Lapwing ACSR and OPGW will be installed.

**Total Cost**

The total cost estimate for this Network Upgrade is:

\$	47,276,805	345 kV Transmission Line
\$	0	345 kV Substation
\$	141,830	AFUDC
\$	0	Contingency
<hr/>		
\$	47,418,635	Total

This estimate is accurate to +/- twenty (20) percent, based on current prices, in accordance with Attachment A of Appendix 4 of the Interconnection Facilities Study Agreement. However, recent cost fluctuations in materials are very significant and the accuracy of this estimate at the time of actual settings cannot be assured.

**Time Estimate**

Time estimates are based on current version of the project schedule and some processes of each category run concurrently.

Engineering Time	12-18	Months
Procurement Time	12-18	Months
Construction Time	12	Months
<b>Total Project Length</b>	<b>36-48</b>	<b>Months</b>

**Figure 5 – Viola – Renfrow 345 kV**

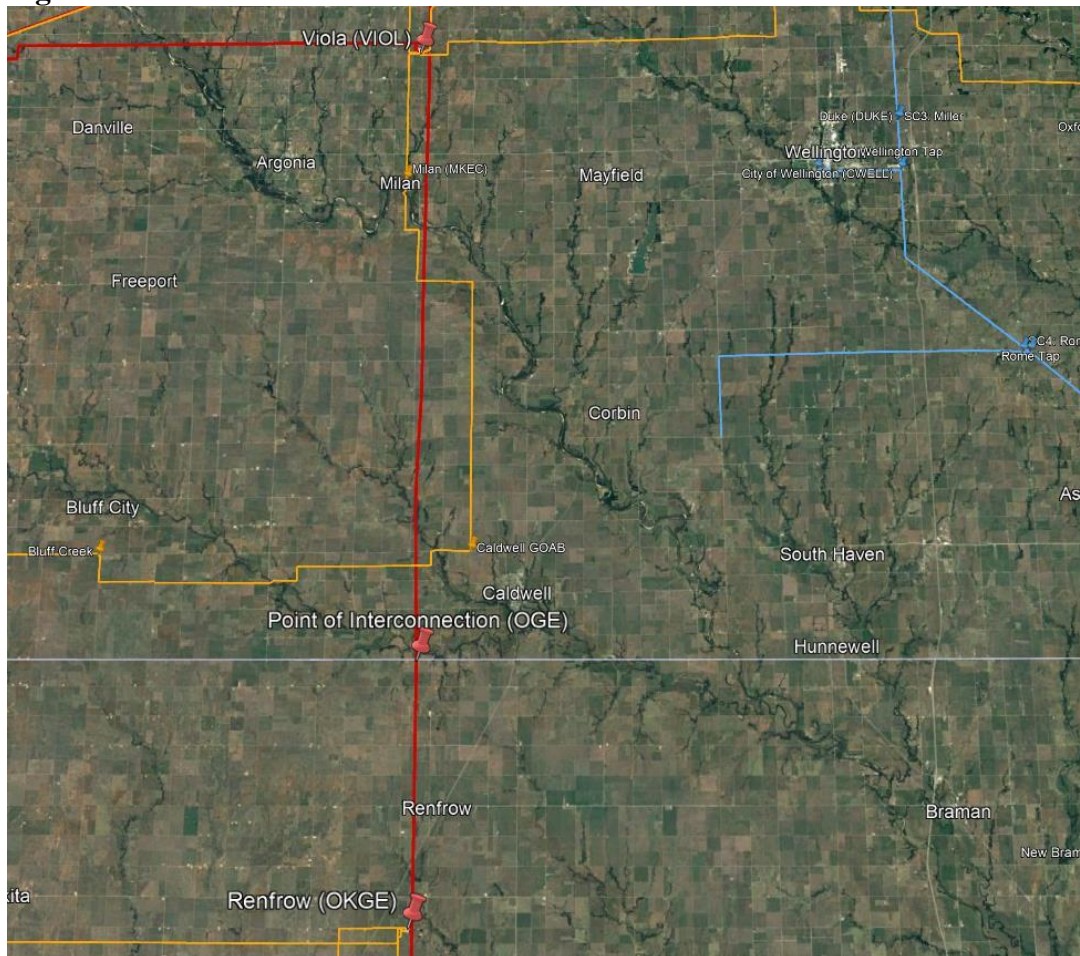



# **AEP Generation Interconnection**

## **Facilities Study Report**

**for**

**DISIS 2017-002**

**GEN-2017-171, GEN-2017-172, and GEN-  
2017-173**

**345 kV Lawton Eastside-Terry Road  
transmission line**

**Stephens County, Oklahoma**

**March 2023**

## 1 Facilities Study Summary

American Electric Power (AEP) Southwest Transmission Planning performed the following study at the request of the Southwest Power Pool (SPP) for SPP Generation Interconnection request DISIS-2017-002, GEN-2017-171, GEN-2017-172, and GEN-2017-173. Per the SPP Generator Interconnection Procedures (GIP), SPP requested that AEP perform an Interconnection Facilities Studies (IFS) for Network Upgrade(s) in accordance with Section 8.11 for the following Interconnection and/or Network Upgrade(s):

### 1.1 Project Description

GEN-2017-171, GEN-2017-172, and GEN-2017-173 proposes to install a 250 MW solar generating facility in Stephens County, Oklahoma (Figure 2). The point of interconnection for the generating facility will be AEP's 345 kV Lawton Eastside – Terry Road transmission line (Figure 1).

### 1.2 AEP's Scope of Work to Facilitate Interconnection

- To accommodate the interconnection to AEP's existing 345 kV Lawton Eastside – Terry Road transmission line, a new 345 kV, 3-breaker ring bus station will be installed. Also, AEP will complete any needed remote work at the 345 kV Lawton Eastside and Terry Road stations associated with this project. The design and construction of the new station will meet all AEP specifications. Bus work and disconnect switches will be designed to accommodate the loading requirements, and circuit breakers will be rated to ensure adequate load and fault interrupting capability. AEP will own, operate and maintain the new 345 kV ring bus station.
- Installation of associated protection and control equipment, SCADA, and revenue metering will be required at the new 345 kV ring bus station. AEP reserves the right to specify the final acceptable configuration considering design practices, future expansion, and compliance requirements.
- AEP will extend one span of 345 kV transmission line from the generator's terminal at new 345 kV ring bus station to the GEN-2017-171, GEN-2017-172, and GEN-2017-173 POI. AEP will build and own the first transmission line structure outside of new 345 kV ring bus station, to which AEP's transmission line conductor will attach. Right of Way (ROW) will be required for this span.
- It is understood that the Interconnection Customer is responsible for all of the connection costs associated with interconnecting GEN-2017-171, GEN-2017-172, and GEN-2017-173 to the AEP transmission system. The cost of the customer's generating



facility and the costs for the line connecting the generating facility to AEP’s transmission system (Beyond the first span exiting the POI) are not included in this report; these are assumed to be the Customer’s responsibility.

- The customer will be responsible for the cost of constructing a fiber-optic connection from their telecom equipment to AEP’s new 345 kV ring bus station’s.

### 1.3 Short Circuit Evaluation

- It is standard practice for AEP to recommend replacing a circuit breaker when the current through the breaker for a fault exceeds 100% of its interrupting rating with recloser de-rating applied, as determined by the ANSI/IEEE C37.5-1979, C37.010-1979 & C37.04-1979 breaker rating methods.
- In the AEP system, no breakers were found to exceed their interrupting capability after the addition of the generation and related facilities. Therefore, there are no additional short circuit upgrade costs associated with the DISIS-2017-002, GEN-2017-171, GEN-2017-172, and GEN-2017-173 interconnection.

### 1.4 Stability Evaluation

Based on the results of the 2017-002 DISIS short circuit and stability report, AEP is not aware of any instances where the system does not meet TPL-001 stability performance requirements for the planning events and generation dispatch conditions that were considered in this DISIS study.

### 1.5 Interconnection Cost of Facilities Included in the Facilities Study:

Network Upgrades (Install 3-breaker ring bus and associated work)	\$17,851,666
Transmission Owner Interconnection Facilities (TOIF)(GEN-2017-171, GEN-2017-172, and GEN-2017-173 are combined, sharing one terminal at the AEP station)	\$3,876,319
Remote End Work	\$286,302
<b>Total Cost</b>	<b>\$22,014,287</b>

*The estimates do not include the impact that delays in obtaining ROW, permits, or other approvals may have.*

### 1.6 Project Lead time

Project in-service date is projected to be 30 months after the issuance of Authorization to Proceed from the Interconnection Customer.

Figure 1: Point of Interconnection (POI INFORMATION) One-Line Diagram

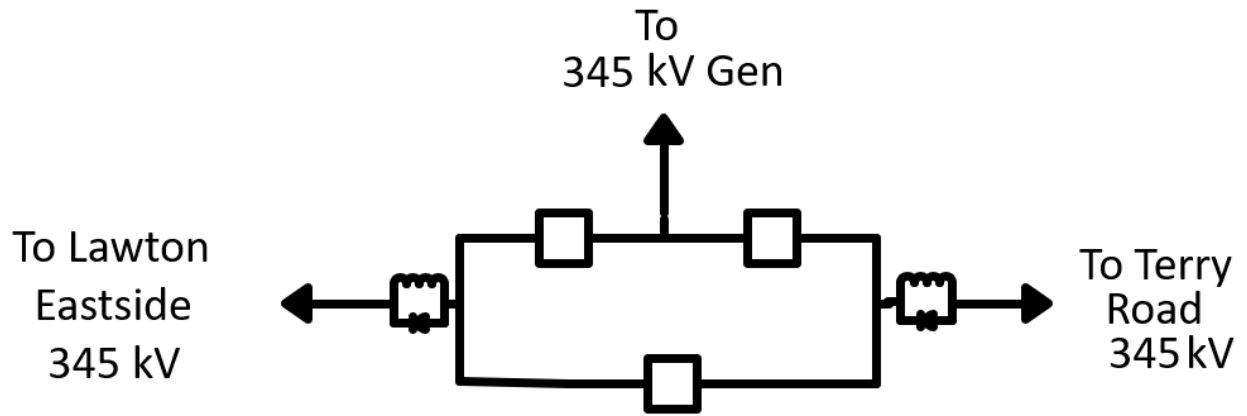
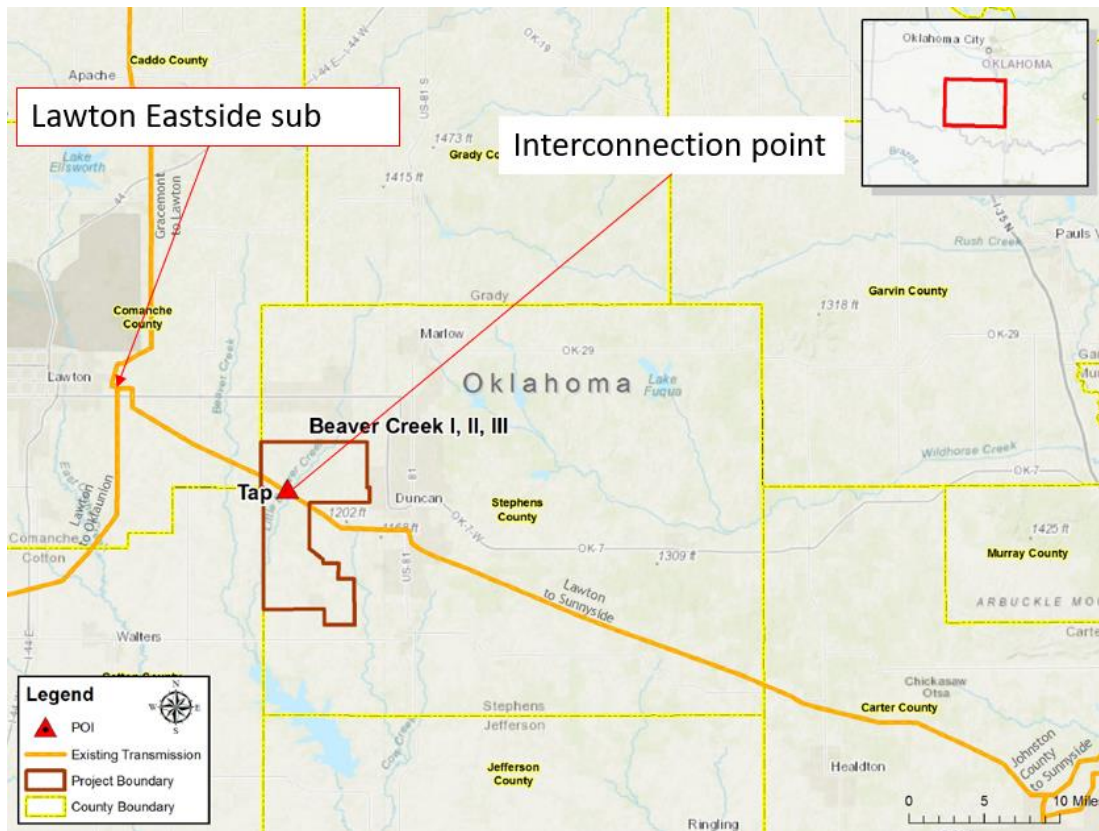

Figure 2: Point of Interconnection Map





## **FACILITY STUDY**

**for**

**IFS-2017-002-156487 Network Upgrades  
For  
DISIS-2017-002**

Rocky Point Terminal Upgrade  
In Carter County  
Oklahoma

March 22, 2023

Chris Rich, P.E.  
Transmission Planning Engineer  
**OG&E Electric Services**

## **Summary**

Pursuant to the tariff and at the request of the Southwest Power Pool (SPP), Oklahoma Gas and Electric (OG&E) performed the following Facility Study for Network Upgrades to satisfy the Facility Study Agreement executed by the requesting customer for SPP IFS-2017-002 for Network Upgrades. The request for interconnection was placed with SPP in accordance SPP's Open Access Transmission Tariff, which covers new generation interconnections on SPP's transmission system. The requirement for the Network Upgrade is to upgrade the terminal equipment at Rocky Point Substation to support 270 MVA on the Rocky Point to Sunnyside 138kV line. This will necessitate equipment to be updated in the Sunnyside Sub. The total cost for OKGE to complete these upgrades is \$634,858.

## Table of Contents

Table of Contents	3
Introduction	4
Network Upgrade Facilities	5
Network Upgrade Costs	6
Map of Interconnection	7

## **Introduction**

The Southwest Power Pool has requested a Facility Study for Network Upgrades within the service territory of OG&E Electric Services (OKGE) in Carter County, Oklahoma. The proposed Network Upgrade Facilities are for the upgrade of terminal equipment at Rocky Point Substation to support 270 MVA on the Rocky Point to Sunnyside 138kV line. This will necessitate equipment to be updated in the Sunnyside Sub.

Network Constraints in the Southwest Public Service (SPS), OKGE and Western Farmers Electric Cooperative (WFEC) systems may be verified with a transmission service request and associated studies.

Other Network Constraints in the American Electric Power West (AEPW), Southwest Public Service (SPS), OKGE and Western Farmers Electric Cooperative (WFEC) systems may be verified with a transmission service request and associated studies.

## **Network Upgrade Facilities**

The primary objective of this study is to identify network upgrades. The requirement for the Network Upgrade is to upgrade the terminal equipment at Rocky Point Substation to support 270 MVA on the Rocky Point to Sunnyside 138kV line on the OG&E transmission system to accommodate generator interconnection requests identified in SPP-GI DISIS-2017-002. These 138kV network upgrades shall be constructed and maintained by OKGE. Updating the line terminal at Rocky Point would necessitate that we match equipment at Sunnyside.

The total cost for OKGE to complete these upgrades is estimated at \$634,858.

This Facility Study does not guarantee the availability of transmission service necessary to deliver the additional generation to any specific point inside or outside the Southwest Power Pool (SPP) transmission system. The transmission network facilities may not be adequate to deliver the additional generation output to the transmission system. If the customer requests firm transmission service under the SPP Open Access Transmission Tariff at a future date, Network Upgrades or other new construction may be required to provide the service requested under the SPP OATT.

The costs of the Network Upgrade to the OKGE transmission system requested by SPP-GI DISIS-2017-002 are listed in Table 1.

Short Circuit Fault Duty Evaluation

It is standard practice for OG&E to recommend replacing a circuit breaker when the current through the breaker for a fault exceeds 100% of its interrupting rating with re-closer de-rating applied, as determined by the ANSI/IEEE C37.5-1979, C37.010-1979 & C37.04-1979 breaker rating methods.

For this Network Upgrade, no breakers were found to exceed their interrupting capability after the upgrades to the line and related facilities. OG&E found no breakers that exceeded their interrupting capabilities on their system. Therefore, there is no short circuit upgrade costs associated with this DISIS-2017-002 Network Upgrade.

**Table 1: Required Interconnection Network Upgrade Facilities**

Facility	ESTIMATED COST (2023 DOLLARS)
Lead time	18 months
OKGE – <b>Network Upgrades</b> Update line terminals at Rocky Point and Sunnyside on the 138kV Transmission Line and associated relay and control equipment.	\$634,858.
<b>Total</b>	\$634,858.

Prepared by:  
Chris Rich, PE  
Staff Engineer, Transmission Planning  
richcs@oge.com

March 21, 2023

Reviewed by:  
Adam Snapp, P.E.  
Manager - Transmission Planning  
snappad@oge.com

March 27, 2023



# Rocky Point Sub to Sunnyside Sub

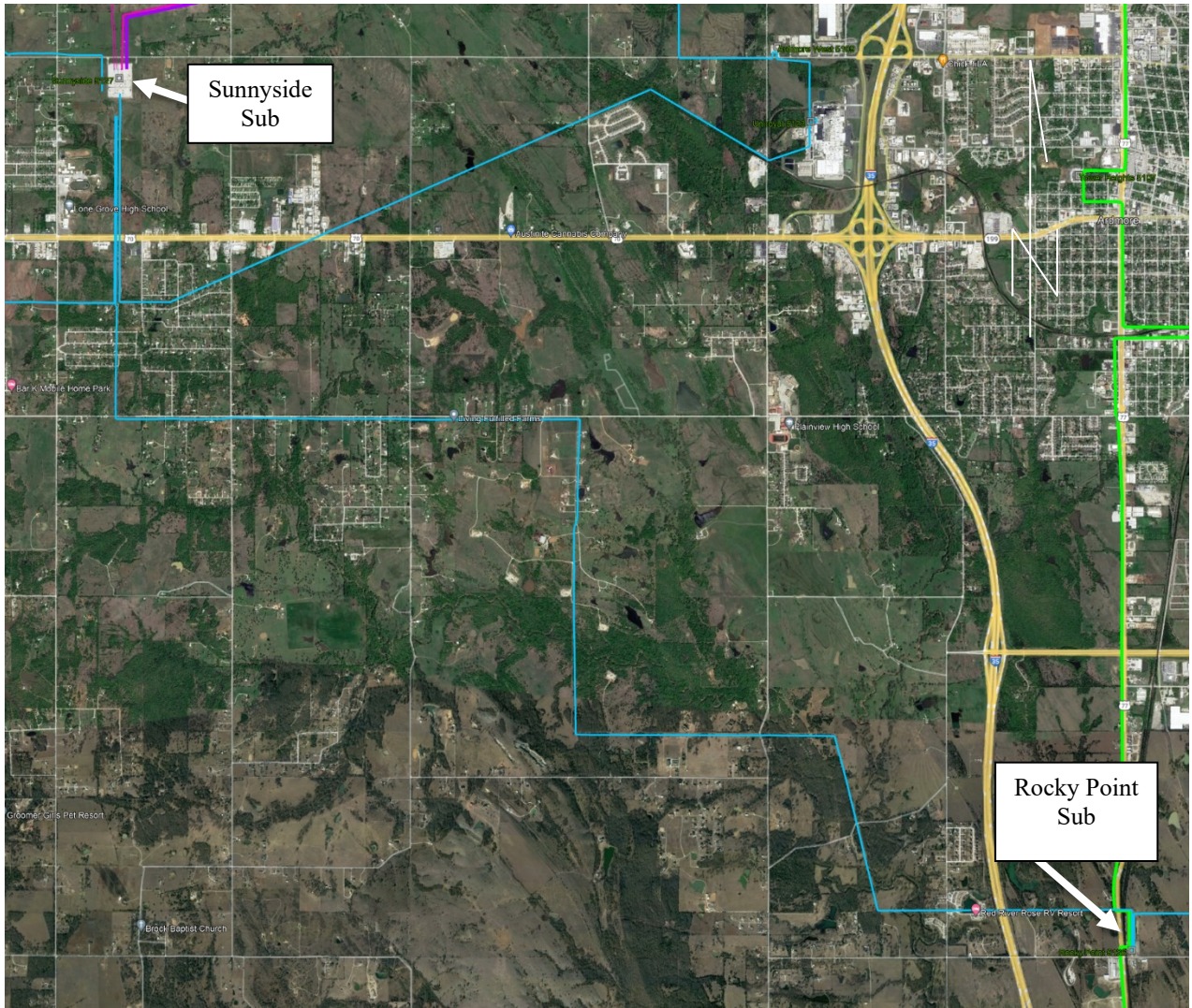



## **FACILITY STUDY**

**for**

### **IFS-2017-002-156496 Network Upgrades For DISIS-2017-002**

Switch Out Border Line Reactor  
In Beckham County  
Oklahoma

March 21, 2023

Chris Rich, P.E.  
Transmission Planning Engineer  
**OG&E Electric Services**

## **Summary**

Pursuant to the tariff and at the request of the Southwest Power Pool (SPP), Oklahoma Gas and Electric (OG&E) performed the following Facility Study for Network Upgrades to satisfy the Facility Study Agreement executed by the requesting customer for SPP IFS-2017-002-1 for Network Upgrades. The request for interconnection was placed with SPP in accordance SPP's Open Access Transmission Tariff, which covers new generation interconnections on SPP's transmission system. The requirements for the Network Upgrade are to install one 345kV Reactor breaker/switch, and associated relay and control equipment in Border substation. The total cost for OKGE to complete these upgrades is \$1,790,448.

## Table of Contents

Table of Contents	3
Introduction	4
Interconnection Facilities	5
Interconnection Costs	6
One-Line diagram of Interconnection	7

## **Introduction**

The Southwest Power Pool has requested a Facility Study for Network Upgrades within the service territory of OG&E Electric Services (OKGE) in Beckham County Oklahoma. The proposed Network Upgrade Facilities are for the addition of a 345kV breaker for the existing 50 Mvar reactor at Border substation in Beckham County, Oklahoma to allow for remote switching.

Network Constraints in the Southwest Public Service (SPS), OKGE and Western Farmers Electric Cooperative (WFEC) systems may be verified with a transmission service request and associated studies.

Other Network Constraints in the American Electric Power West (AEPW), Southwest Public Service (SPS), OKGE and Western Farmers Electric Cooperative (WFEC) systems may be verified with a transmission service request and associated studies.

## **Network Upgrade Facilities**

The primary objective of this study is to identify network upgrades. The requirements for this Network Upgrade consist of installing a 345kV breaker for the existing 50 Mvar reactor at Border substation on the OG&E transmission system to allow for remote switching and to accommodate generator interconnection requests identified in SPP-GI DISIS-2016-002-1. These 345kV network upgrades shall be constructed and maintained by OKGE.

The total cost for OKGE to install one 345kV reactor breaker, and associated relay and control equipment to allow an existing 50 Mvar Reactor in Border substation to be remotely switched is estimated at \$1,790,448.

This Facility Study does not guarantee the availability of transmission service necessary to deliver the additional generation to any specific point inside or outside the Southwest Power Pool (SPP) transmission system. The transmission network facilities may not be adequate to deliver the additional generation output to the transmission system. If the customer requests firm transmission service under the SPP Open Access Transmission Tariff at a future date, Network Upgrades or other new construction may be required to provide the service requested under the SPP OATT.

The costs of interconnecting the facility to the OKGE transmission system are listed in Table 1.

### Short Circuit Fault Duty Evaluation

It is standard practice for OG&E to recommend replacing a circuit breaker when the current through the breaker for a fault exceeds 100% of its interrupting rating with re-closer de-rating applied, as determined by the ANSI/IEEE C37.5-1979, C37.010-1979 & C37.04-1979 breaker rating methods.

For this Network Upgrade, no breakers were found to exceed their interrupting capability after the addition of the one breaker and related facilities. OG&E found no breakers that exceeded their interrupting capabilities on their system. Therefore, there is no short circuit upgrade costs associated with this DISIS-2017-002 Network Upgrade.

**Table 1: Required Interconnection Network Upgrade Facilities**

Facility	ESTIMATED COST (2023 DOLLARS)
Lead time	20 months
OKGE – <b>Network Upgrades</b> at Border Sub. Install 1-345kV Reactor Breaker/switch and associated relay and control equipment.	\$1,790,448
<b>Total</b>	<b>\$1,790,448</b>

Prepared by:  
Chris Rich, PE  
Staff Engineer, Transmission Planning  
richcs@oge.com

March 21, 2023

Reviewed by:  
Adam Snapp, P.E.  
Manager - Transmission Planning  
snappad@oge.com

March 27, 2023

# Border Substation

